

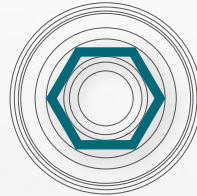

**JDENTAL CARE**  
*just smile*

# JD EVOLUTION plus

*Simple insertion, natural stability*



hexagonal connection



Made in Italy

## SIMPLE INSERTION, NATURAL STABILITY

### features & advantages

- Internal hex connection with lead-in bevel
- Anatomic coronal collar
- Expanding tapered inner body
- Self-cutting capacity in both directions
- Apical cutting blades
- The connection is universally recognized by all the main digital libraries
- Reduces stress concentration on the crestal bone and maximizes bone volume around the implant neck for stable hard and soft tissues
- Makes it possible to achieve high primary stability

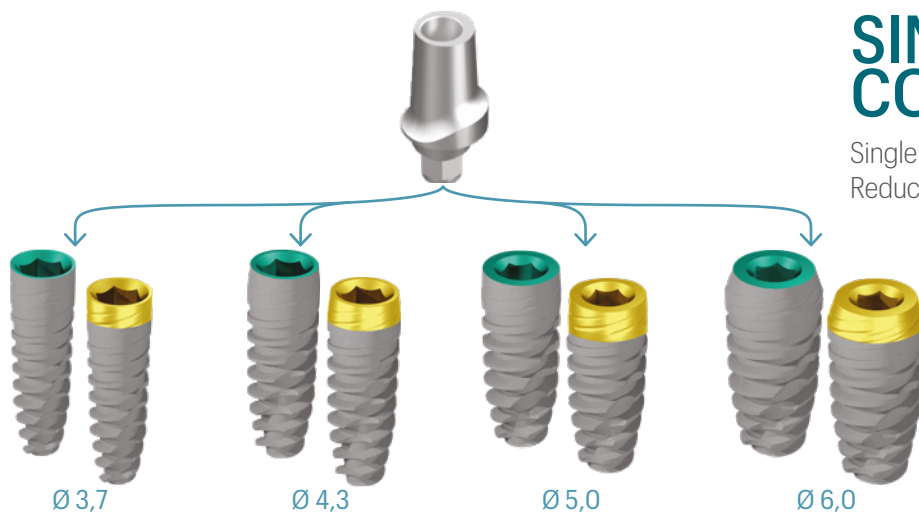
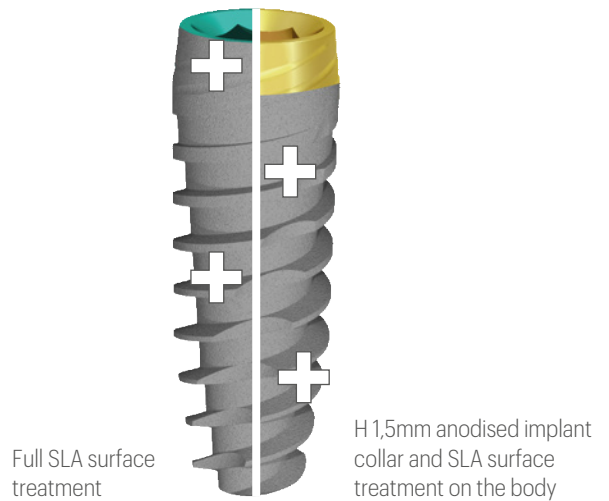

## SINGLE PROSTHETIC CONNECTION

Single prosthetic connection for all diameters  
Reduced inventory and enhanced working flexibility

## PRODUCT SPECIFICATIONS

The JDEvolution Plus dental implants are available in the diameters and lengths shown in the following table:

IMPLANT DIAMETER	TIP DIAMETER	ABUTMENT INTERFACE	PLATFORM DIAMETER	LENGTH						
				6	8	10	11,5	13	15	18
Ø 3,7	2,4	3,4	3,7		8	10	11,5	13	15	18
Ø 4,0	2,4	3,4	3,8	6	8	10	11,5	13	15	18
Ø 4,3	2,8	3,4	4,0	6	8	10	11,5	13	15	18
Ø 5,0	3,2	3,4	4,8	6	8	10	11,5	13	15	18
Ø 6,0	4,0	3,4	5,0	6	8	10	11,5	13	15	

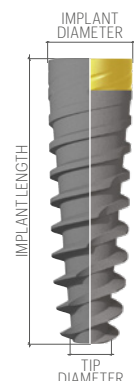
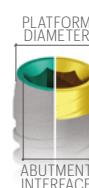

Note: All measurements in mm

# PRODUCT CATALOGUE

Note: all measurements of diameters and lengths are in mm

## Implants:

### Ø 3,7

EV37080:	JDEvolution Plus Ø 3.7 L 8
EV37100:	JDEvolution Plus Ø 3.7 L 10
EV37115:	JDEvolution Plus Ø 3.7 L 11.5
EV37130:	JDEvolution Plus Ø 3.7 L 13
EV37150:	JDEvolution Plus Ø 3.7 L 15
EV37180:	JDEvolution Plus Ø 3.7 L 18



### Ø 4,3

EV43060:	JDEvolution Plus Ø 4.3 L 6
EV43080:	JDEvolution Plus Ø 4.3 L 8
EV43100:	JDEvolution Plus Ø 4.3 L 10
EV43115:	JDEvolution Plus Ø 4.3 L 11.5
EV43130:	JDEvolution Plus Ø 4.3 L 13
EV43150:	JDEvolution Plus Ø 4.3 L 15
EV43180:	JDEvolution Plus Ø 4.3 L 18

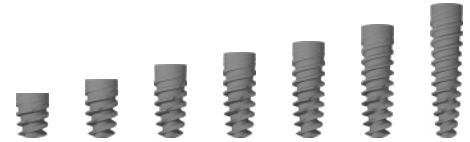

### Ø 5,0

EV50060:	JDEvolution Plus Ø 5.0 L 6
EV50080:	JDEvolution Plus Ø 5.0 L 8
EV50100:	JDEvolution Plus Ø 5.0 L 10
EV50115:	JDEvolution Plus Ø 5.0 L 11.5
EV50130:	JDEvolution Plus Ø 5.0 L 13
EV50150:	JDEvolution Plus Ø 5.0 L 15
EV50180:	JDEvolution Plus Ø 5.0 L 18

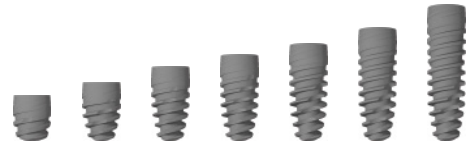

### Ø 6,0

EV60060:	JDEvolution Plus Ø 6.0 L 6
EV60080:	JDEvolution Plus Ø 6.0 L 8
EV60100:	JDEvolution Plus Ø 6.0 L 10
EV60115:	JDEvolution Plus Ø 6.0 L 11.5
EV60130:	JDEvolution Plus Ø 6.0 L 13
EV60150:	JDEvolution Plus Ø 6.0 L 15



## Anodised implant collar:

### Ø 3,7

EVA37080:	JDEvolution Plus Anodized Collar Ø 3.7 L 8
EVA37100:	JDEvolution Plus Anodized Collar Ø 3.7 L 10
EVA37115:	JDEvolution Plus Anodized Collar Ø 3.7 L 11.5
EVA37130:	JDEvolution Plus Anodized Collar Ø 3.7 L 13
EVA37150:	JDEvolution Plus Anodized Collar Ø 3.7 L 15
EVA37180:	JDEvolution Plus Anodized Collar Ø 3.7 L 18

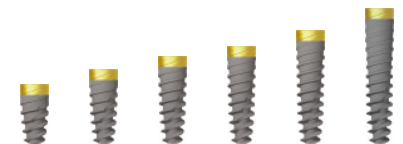

### Ø 4,3

EVA43060:	JDEvolution Plus Anodized Collar Ø 4.3 L 6
EVA43080:	JDEvolution Plus Anodized Collar Ø 4.3 L 8
EVA43100:	JDEvolution Plus Anodized Collar Ø 4.3 L 10
EVA43115:	JDEvolution Plus Anodized Collar Ø 4.3 L 11.5
EVA43130:	JDEvolution Plus Anodized Collar Ø 4.3 L 13
EVA43150:	JDEvolution Plus Anodized Collar Ø 4.3 L 15
EVA43180:	JDEvolution Plus Anodized Collar Ø 4.3 L 18



### Ø 5,0

EVA50060:	JDEvolution Plus Anodized Collar Ø 5.0 L 6
EVA50080:	JDEvolution Plus Anodized Collar Ø 5.0 L 8
EVA50100:	JDEvolution Plus Anodized Collar Ø 5.0 L 10
EVA50115:	JDEvolution Plus Anodized Collar Ø 5.0 L 11.5
EVA50130:	JDEvolution Plus Anodized Collar Ø 5.0 L 13
EVA50150:	JDEvolution Plus Anodized Collar Ø 5.0 L 15
EVA50180:	JDEvolution Plus Anodized Collar Ø 5.0 L 18



### Ø 6,0

EVA60060:	JDEvolution Plus Anodized Collar Ø 6.0 L 6
EVA60080:	JDEvolution Plus Anodized Collar Ø 6.0 L 8
EVA60100:	JDEvolution Plus Anodized Collar Ø 6.0 L 10
EVA60115:	JDEvolution Plus Anodized Collar Ø 6.0 L 11.5
EVA60130:	JDEvolution Plus Anodized Collar Ø 6.0 L 13
EVA60150:	JDEvolution Plus Anodized Collar Ø 6.0 L 15



## JDEvolution Plus T:

EVT40060:	JDEvolution Plus Ø 4.0 L 6
EVT40080:	JDEvolution Plus Ø 4.0 L 8
EVT40100:	JDEvolution Plus Ø 4.0 L 10
EVT40115:	JDEvolution Plus Ø 4.0 L 11.5
EVT40130:	JDEvolution Plus Ø 4.0 L 13
EVT40150:	JDEvolution Plus Ø 4.0 L 15
EVT40180:	JDEvolution Plus Ø 4.0 L 18



## Ø 4,0mm Implants (Tilted):

EVA40150:	JDEvolution Plus Anodized Collar Ø 4.0 L 15
EVA40180:	JDEvolution Plus Anodized Collar Ø 4.0 L 18



## Cover screw:

EVCS:	Cover Screw JDEvolution Plus
EVCS6:	Cover Screw Ø 6.0 JDEvolution Plus



## Healing Abutment:

EVHA43:	Healing Abutment Ø 4.0 H 3.0 JDEvolution Plus
EVHA45:	Healing Abutment Ø 4.0 H 5.0 JDEvolution Plus
EVHA47:	Healing Abutment Ø 4.0 H 7.0 JDEvolution Plus
EVHA53:	Healing Abutment Ø 5.0 H 3.0 JDEvolution Plus
EVHA55:	Healing Abutment Ø 5.0 H 5.0 JDEvolution Plus
EVHA57:	Healing Abutment Ø 5.0 H 7.0 JDEvolution Plus
EVHA59:	Healing Abutment Ø 5.0 H 9.0 JDEvolution Plus
EVHA63:	Healing Abutment Ø 6.0 H 3.0 JDEvolution Plus
EVHA65:	Healing Abutment Ø 6.0 H 5.0 JDEvolution Plus
EVHA67:	Healing Abutment Ø 6.0 H 7.0 JDEvolution Plus
EVHA753:	Healing Abutment Ø 7.5 H 3.0 JDEvolution Plus
EVHA755:	Healing Abutment Ø 7.5 H 5.0 JDEvolution Plus
EVHA54TS:	Healing Abutment Tissue Ø 5.0 H 4.0 JDEvolution Plus
EVHA56TS:	Healing Abutment Tissue Ø 5.0 H 6.0 JDEvolution Plus



## Impression coping:

### OPEN TRAY

EVICOT4C:	Impression Coping Open Tray Ø 4.0 JDEvolution Plus
EVICOT5C:	Impression Coping Open Tray Ø 5.0 JDEvolution Plus
EVICOT6C:	Impression Coping Open Tray Ø 6.0 JDEvolution Plus
EVICOTNEC:	Impression Coping Open Tray Non Engaging JDEvolution Plus
EVICOTS:	Impression Coping Open Tray Screw JDEvolution Plus
EVICOT5TSC:	Impression Coping Tissue Open Tray Ø 5.0 JDEvolution Plus

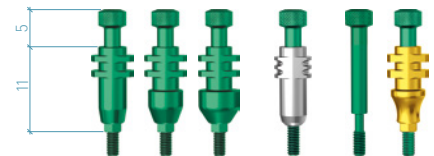

### CLOSED TRAY

EVICCT4C:	Impression Coping Closed Tray Ø 4.0 JDEvolution Plus
EVICCT5C:	Impression Coping Closed Tray Ø 5.0 JDEvolution Plus
EVICCT6C:	Impression Coping Closed Tray Ø 6.0 JDEvolution Plus
EVICCTS:	Impression Coping Closed Tray Screw JDEvolution Plus
EVICCT1C:	Impression Coping Closed Tray Direct Press Fit JDEvolution Plus



## Temporary Abutment:

EVTAE:	Temporary Abutment Engaging JDEvolution Plus
EVTAEPC:	Temporary Abutment Engaging Peek JDEvolution Plus
EVTANEC:	Temporary Abutment Non Engaging JDEvolution Plus
EVTAEETSC:	Temporary Abutment Tissue Engaging JDEvolution Plus
EVTANETSC:	Temporary Abutment Tissue Non Engaging JDEvolution Plus

Torque recommended 30 Ncm

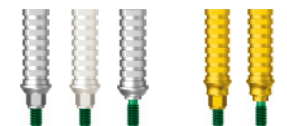

## Straight Abutment:

EVNSA4510C:	Straight Abutment Ø 4.5 H 1.5 JDEvolution Plus
EVNSA4520C:	Straight Abutment Ø 4.5 H 2.0 JDEvolution Plus
EVNSA4540C:	Straight Abutment Ø 4.5 H 4.0 JDEvolution Plus
EVNSA5020C:	Straight Abutment Ø 5.0 H 2.0 JDEvolution Plus
EVNSA5040C:	Straight Abutment Ø 5.0 H 4.0 JDEvolution Plus
EVNSA6020C:	Straight Abutment Ø 6.0 H 2.0 JDEvolution Plus
EVNSA6040C:	Straight Abutment Ø 6.0 H 4.0 JDEvolution Plus



Torque recommended 30 Ncm



EVNSA5020TSC: Straight Abutment Tissue Ø 5.0 H 2.0 JDEvolution Plus  
 EVNSA5040TSC: Straight Abutment Tissue Ø 5.0 H 4.0 JDEvolution Plus

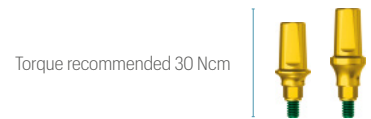

### GP Abutment:

EV15GPAEC: GP Abutment 15° JDEvolution Plus  
 EV25GPAEC: GP Abutment 25° JDEvolution Plus  
 EVGPA40EC: GP Abutment Engaging Ø 4.0 JDEvolution Plus  
 EVGPA40NEC: GP Abutment Non Engaging Ø 4.0 JDEvolution Plus  
 EVGPAEC: GP Abutment Engaging Ø 5.0 JDEvolution Plus  
 EVGPA50NEC: GP Abutment Non Engaging Ø 5.0 JDEvolution Plus  
 EVGPAEPC: GP Abutment Engaging Peek Ø 5.0 JDEvolution Plus  
 EVGPA60EC: GP Abutment Engaging Ø 6.0 JDEvolution Plus



### Anatomic Abutment:

EVEA15: Anatomic Abutment H 1.5 JDEvolution Plus  
 EVEA30: Anatomic Abutment H 3.0 JDEvolution Plus  
 EV15A15: 15° Angulated Anatomic Abutment Ø 5.0 H 1.5 JDEvolution Plus  
 EV15A15N: 15° Angulated Anatomic Abutment Ø 4.5 H 1.5 JDEvolution Plus  
 EV15A30: 15° Angulated Anatomic Abutment Ø 5.0 H 3.0 JDEvolution Plus  
 EV15A30N: 15° Angulated Anatomic Abutment Ø 4.5 H 3.0 JDEvolution Plus  
 EV25A15: 25° Angulated Anatomic Abutment Ø 5.0 H 1.5 JDEvolution Plus  
 EV25A30: 25° Angulated Anatomic Abutment Ø 5.0 H 3.0 JDEvolution Plus



### Rapid Abutment:

EVRA15C: Rapid Abutment H 1.5 JDEvolution Plus  
 EVRA30C: Rapid Abutment H 3.0 JDEvolution Plus  
 EVRA15D: Rapid Abutment w/o Healing Cap and Coping H 1.5 JDEvolution Plus  
 EVRA30D: Rapid Abutment w/o Healing Cap and Coping H 3.0 JDEvolution Plus  
 EVRAHC: Rapid Abutment Healing Cap  
 EVRAIC: Rapid Abutment Impression Coping  
 EVRAAR: Rapid Abutment Replica

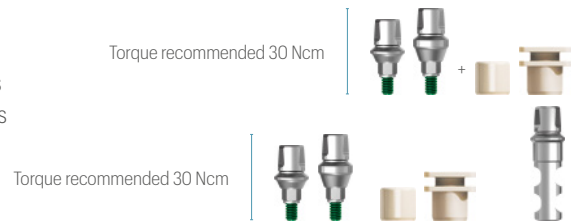

### Wax up Abutment:

EVWAEC: Wax-Up Abutment Engaging JDEvolution Plus  
 EVWANEC: Wax-Up Abutment Non Engaging JDEvolution Plus

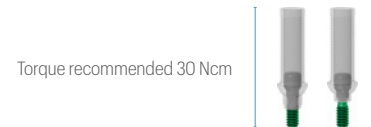

### Cobalt-Chrome Abutment:

EVCCCEC: Chrome-Cobalt Abutment Engaging JDEvolution Plus  
 EVCCNEC: Chrome-Cobalt Abutment Non Engaging JDEvolution Plus  
 EVCACCNEC: Cobalt-Chrome Conical Abutment Non Engaging JDEvolution Plus

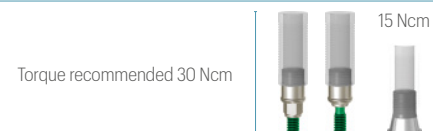

### Gold Abutment:

EVGAEC: Gold Abutment Engaging JDEvolution Plus  
 EVGANEC: Gold Abutment Non Engaging JDEvolution Plus

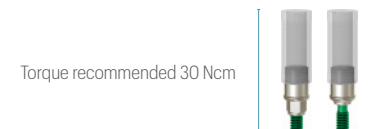

### Conical Abutment:

EVNCA10C: Conical Abutment Straight H 1.0 JDEvolution Plus  
 EVNCA15C: Conical Abutment Straight H 1.5 JDEvolution Plus  
 EVNCA20C: Conical Abutment Straight H 2.0 JDEvolution Plus  
 EVNCA30C: Conical Abutment Straight H 3.0 JDEvolution Plus  
 EVNCA40C: Conical Abutment Straight H 4.0 JDEvolution Plus  
 EVNCA70C: Conical Abutment Straight H 7.0 JDEvolution Plus  
 EVNCA90C: Conical Abutment Straight H 9.0 JDEvolution Plus  
 EVNCA15TSC: Conical Abutment Tissue Straight H 1.5 JDEvolution Plus  
 EVNCA30TSC: Conical Abutment Tissue Straight H 3.0 JDEvolution Plus  
 EVNCA40TSC: Conical Abutment Tissue Straight H 4.0 JDEvolution Plus  
 EVNCA50TSC: Conical Abutment Tissue Straight H 5.0 JDEvolution Plus



EVCA1725C:	Conical Abutment Angulated 17° H 2.5 JDEvolution Plus
EVCA1735C:	Conical Abutment Angulated 17° H 3.5 JDEvolution Plus
EVCA3025C:	Conical Abutment Angulated 30° H 2.5 JDEvolution Plus
EVCA3035C:	Conical Abutment Angulated 30° H 3.5 JDEvolution Plus
EVCA1725TSC:	Conical Abutment Tissue Angulated 17° H 2.5 JDEvolution Plus
EVCA1735TSC:	Conical Abutment Tissue Angulated 17° H 3.5 JDEvolution Plus
EVA275C:	Conical Abutment Tissue Angulated 17° H 5.0 JDEvolution Plus
EVCA3025TSC:	Conical Abutment Tissue Angulated 30° H 2.5 JDEvolution Plus
EVCA3035TSC:	Conical Abutment Tissue Angulated 30° H 3.5 JDEvolution Plus
EVCA3050TSC:	Conical Abutment Tissue Angulated 30° H 5.0 JDEvolution Plus
EVA137C:	Conical Abutment Straight Engaging H 1.5 JDEvolution Plus
EVA138C:	Conical Abutment Straight Engaging H 3.0 JDEvolution Plus
EVS105:	Screw for Conical Abutment Straight Engaging H 1.5 JDEvolution Plus
EVS106:	Screw for Conical Abutment Straight Engaging H 3.0 JDEvolution Plus
EVCASA:	Screw for Angulated Conical Abutment JDEvolution Plus
EVCAPS:	Prosthetic Screw Conical Abutment JDEvolution Plus
EVCAPSL:	Prosthetic Screw Conical Abutment Long JDEvolution Plus
EVCAPSA	Prosthetic Screw Angulated for Conical Abutment JDEvolution
EVCAICOTEC:	Conical Abutment Impression Coping Engaging Open Tray JDEvolution Plus
EVCAICOTC:	Conical Abutment Impression Coping Open Tray JDEvolution Plus
EVCAICOTLC:	Conical Abutment Impression Coping Open Tray Long JDEvolution Plus
EVCAICOT02:	Screw for Conical Abutment Impression Coping Open Tray JDEvolution Plus
EVCAICOT04:	Screw for Conical Abutment Impression Coping Open Tray Long JDEvolution Plus
EVCAICCTC	Conical Abutment Impression Coping Closed Tray
EVCAHC:	Healing Cap for Conical Abutment JDEvolution Plus
EVCAHCL:	Conical Abutment Healing Cap H 6.0 JDEvolution Plus
EVCAHC9:	Conical Abutment Healing Cap H 9.0 JDEvolution Plus
EVCAHCB:	Conical Abutment Healing Cap Peek JDEvolution Plus
EVCAGPAEC:	GP Abutment Engaging for Conical Abutment JDEvolution Plus
EVCAGPANEC:	GP Abutment Non Engaging for Conical Abutment JDEvolution Plus
EVCATANEWSC:	Temporary Abutment Non Engaging Conical Abutment Smooth for Welding JDEvolution Plus
EVCATANEC:	Temporary Abutment Non Engaging Conical Abutment JDEvolution Plus
EVCATANEWC:	Temporary Abutment Non Engaging Conical Abutment for Welding JDEvolution Plus
EVCAWANEC:	Wax-Up Abutment Non Engaging for Conical Abutment JDEvolution Plus
EVCAAR	Conical Abutment Replica

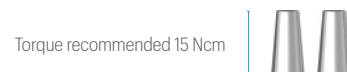
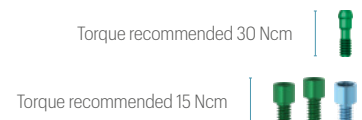
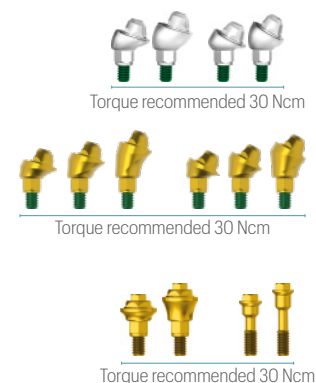

### Prosthetic screw:

EVS:	Prosthetic Screw JDEvolution Plus
EVSA:	Prosthetic Screw Angulated JDEvolution Plus

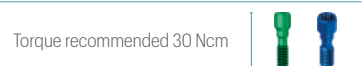

### Interfaces:

EVINTEC:	Interface Engaging JDEvolution Plus
EVINTNEC:	Interface Non Engaging JDEvolution Plus
70287C:	Interface Non Engaging for Conical Abutment JDEvolution Plus

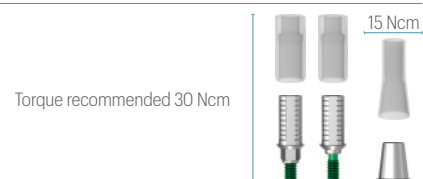

### AS Abutment:

EVASCEC:	AS Abutment Engaging JDEvolution Plus
EVASCNEC:	AS Abutment Non Engaging JDEvolution Plus

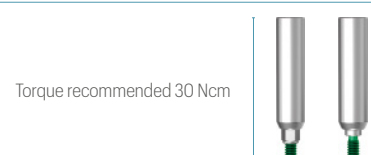

### TiBase, JDSanBody and Implant Replica CAD CAM:

EVSBCEC:	ScanBody Engaging JDEvolution Plus
EVCSBCEC:	ScanBody Conical Abutment JDEvolution Plus
EVCSBCEEC:	ScanBody Engaging Conical Abutment JDEvolution Plus
EVCSBCEESC:	On Top ScanBody Conical Abutment JDEvolution Plus
JDSGIOS	ScanBody Full Arch Tracer
EVHSB53:	On Top ScanBody Engaging Ø 5.0 H 3.0 JDEvolution Plus
EVHSB55:	On Top ScanBody Engaging Ø 5.0 H 5.0 JDEvolution Plus
EVHSB57:	On Top ScanBody Engaging Ø 5.0 H 7.0 JDEvolution Plus
EVSCPC:	ScanPost JDEvolution Plus



EVTIBC:	TiBase Engaging Ø4.25 H 0.5 C 4.7 JDEvolution Plus	Torque recommended 30 Ncm	
EVTIBNEC:	TiBase Non Engaging Ø4.25 H 0.5 C 4.7 JDEvolution Plus		
EVTIB15C:	TiBase Engaging Ø4.25 H 1.5 C 4.7 JDEvolution Plus	Torque recommended 30 Ncm	
EVTIB15NEC:	TiBase Non Engaging Ø4.25 H 1.5 C 4.7 JDEvolution Plus		
EVTIB30C:	TiBase Engaging Ø4.25 H 3.0 C 4.7 JDEvolution Plus	Torque recommended 30 Ncm	
EVTIB30NEC:	TiBase Non Engaging Ø4.25 H 3.0 C 4.7 JDEvolution Plus		
EVTIBNC:	TiBase Long Engaging Ø4.4 H 0.5 C 7.7 JDEvolution Plus	Torque recommended 30 Ncm	
EVTIBNENC:	TiBase Long Non Engaging Ø4.4 H 0.5 C 7.7 JDEvolution Plus		
EVTIB15NC:	TiBase Long Engaging Ø4.4 H 1.5 C 7.7 JDEvolution Plus	Torque recommended 30 Ncm	
EVTIB15NENC:	TiBase Long Non Engaging Ø4.4 H 1.5 C 7.7 JDEvolution Plus		
EVTIB30NC:	TiBase Long Engaging Ø4.4 H 3.0 C 7.7 JDEvolution Plus	Torque recommended 30 Ncm	
EVTIB30NENC:	TiBase Long Non Engaging Ø4.4 H 3.0 C 7.7 JDEvolution Plus		
EVA150C:	TiBase Long Engaging Ø4.4 H 0.5 C 7.7 for Angulated Channel JDEvolution Plus	Torque recommended 30 Ncm	
EVA151C:	TiBase New Non Engaging Ø4.4 H 0.5 C 7.7 for Angulated Channel JDEvolution Plus		
EVA152C:	TiBase Long Engaging Ø4.4 H 1.5 C 7.7 for Angulated Channel JDEvolution Plus	Torque recommended 30 Ncm	
EVA153C:	TiBase New Non Engaging Ø4.4 H 1.5 C 7.7 for Angulated Channel JDEvolution Plus		
EVA154C:	TiBase Long Engaging Ø4.4 H 3.0 C 7.7 for Angulated Channel JDEvolution Plus	Torque recommended 30 Ncm	
EVA155C:	TiBase New Non Engaging Ø4.4 H 3.0 C 7.7 for Angulated Channel JDEvolution Plus		
EVA133C:	Tibase Interface Engaging H 6.0 for Angulated Channel JDEvolution Plus*	Torque recommended 15 Ncm	
EVA134C:	Tibase Interface Non Engaging H 6.0 for Angulated Channel JDEvolution Plus*		
EVA135C:	Tibase Interface Engaging H 10.0 for Angulated Channel JDEvolution Plus*	Torque recommended 15 Ncm	
EVA136C:	Tibase Interface Non Engaging H 10.0 for Angulated Channel JDEvolution Plus*		
EVCAITEC:	Interface CAD CAM Engaging for Conical Abutment JDEvolution Plus (H 7.5)	Torque recommended 15 Ncm	
EVA139C:	TiBase Engaging for Conical Abutment JDEvolution Plus (H 5.0)		
EVCAITC:	Interface CAD CAM Non Engaging for Conical Abutment JDEvolution Plus (H 7.3)	Torque recommended 15 Ncm	
EVCAITBC:	TiBase for Conical Abutment JDEvolution Plus (H 5.0)		
EVS110	Prosthetic Screw Conical Abutment Direct	Torque recommended 30 Ncm	
EVS111	Prosthetic Screw Conical Abutment Direct Long		
EVS112	Prosthetic Screw for Angulated Channel Conical Abutment Direct	Torque recommended 30 Ncm	
EVANCN:	Implant Replica CAD CAM New JDEvolution Plus		
EVCAARC:	Conical Abutment Replica CAD CAM New	Torque recommended 30 Ncm	
EVPMNC:	Pre-milled Abutment Blank JDEvolution Plus		

\*The EVS: prosthetic screw must be used for straight channels and the EVSA: prosthetic screw must be used for angled channels. Prosthetic screws are not included.  
**Note: please contact [info@jdentalcare.com](mailto:info@jdentalcare.com) for the digital library for Exocad, 3Shape and Dental Wings software**

## Conometric Abutment:

EVCP05C:	Conometric Abutment Straight H 0.5 JDEvolution Plus	Torque recommended 30 Ncm	
EVCP10C:	Conometric Abutment Straight H 1.0 JDEvolution Plus		
EVCP20C:	Conometric Abutment Straight H 2.0 JDEvolution Plus	Torque recommended 30 Ncm	
EVCP30C:	Conometric Abutment Straight H 3.0 JDEvolution Plus		
EVCP40C:	Conometric Abutment Straight H 4.0 JDEvolution Plus	Torque recommended 30 Ncm	
EV7CP20C:	7.5° Angulated Conometric Abutment H 2.0 JDEvolution Plus		
EVI5CP20C:	15° Angulated Conometric Abutment H 2.0 JDEvolution Plus	Torque recommended 30 Ncm	
EV22CP20C:	22.5° Angulated Conometric Abutment H 2.0 JDEvolution Plus		
EVA300C:	30° Angulated Conometric Abutment H 2.0 JDEvolution Plus	Torque recommended 30 Ncm	
EVA285C:	7.5° Angulated Conometric Abutment H 3.0 JDEvolution Plus		
EVA286C:	15° Angulated Conometric Abutment H 3.0 JDEvolution Plus	Torque recommended 30 Ncm	
EVA287C:	22.5° Angulated Conometric Abutment H 3.0 JDEvolution Plus		
EVA288C:	30° Angulated Conometric Abutment H 3.0 JDEvolution Plus	Torque recommended 30 Ncm	
EVCP5:	Screw for Conometric Abutment JDEvolution Plus		
EVA130C:	Cap With Pin for Intraoral Welding	Torque recommended 30 Ncm	
EVA131C:	Cap for Partial or Full-Arch Fixed Prosthesis		
EVA132C:	Anti-Rotation Cap for Single Element	Torque recommended 30 Ncm	
EVCPIC:	Conometric Abutment Impression Coping PEEK		
EVCPAN:	Conometric Abutment Replica	Torque recommended 30 Ncm	

## Ball Abutment:

EVBA15:	Ball Abutment H 1.5 JDEvolution Plus	Torque recommended 30 Ncm	
EVBA30:	Ball Abutment H 3.0 JDEvolution Plus		
EVBA50:	Ball Abutment H 5.0 JDEvolution Plus	Torque recommended 30 Ncm	
EVBAA:	Ball Abutment Replica		
EVBAHC:	Ball Abutment Elastic Retention Cap w/Container	Torque recommended 30 Ncm	
EVBAN:	Ball Abutment Retention Cap		

## Emi Abutment:

EVEMI15:	Emi Abutment H 1.5 JDEvolution Plus
EVEMI30:	Emi Abutment H 3.0 JDEvolution Plus
EVEMI50:	Emi Abutment H 5.0 JDEvolution Plus
EVEMISCK	Smart cap attachment Emi Abutment
EVEMIHC	Emi Abutment Elastic Retention Cap w/ Container
EVEMIN	Emi Abutment Elastic Retention Cap (1.2 kg)
EVEMIH	Emi Abutment Container
EVEMIIC	Emi Abutment Plastic Impression Coping
EVEMIICS	Emi Abutment Steel Impression Coping
EVEMINT	Emi Abutment White Retention Cap (1.8 kg)
EVEMINY	Emi Abutment Yellow Retention Cap (0.6 kg)
EVEMINP	Emi Abutment Purple Retention Cap (2.5 kg)
EVEMINB	Emi Abutment Retention Cap for Laboratory
EVEMIEIT	Extractor-insertion Tool For Caps
EVEMIA	Emi Abutment Replica

Torque recommended 30 Ncm

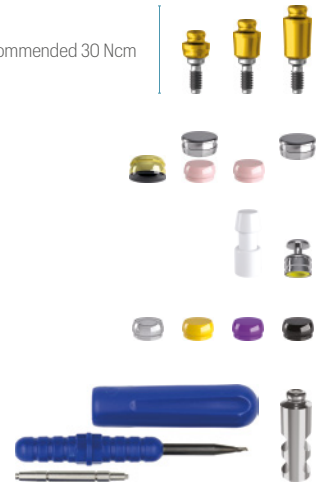

## Implant replica:

EVAN:	Implant Replica JDEvolution Plus
-------	----------------------------------



## Bone Mill:

JDBMNC:	Bone Mill Ø 5.0 and Guide JDEvolution Plus
JDBM6NC:	Bone Mill Ø 6.0 and Guide JDEvolution Plus
JDBMGNN:	Bone Mill Guide JDEvolution Plus

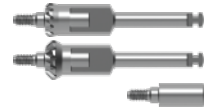

## Short Drills:

JDDICS4	Short Drill Ø 4mm L 6 JDIcon Plus
JDDICS4D	Short Drill Ø 4mm L 6 Dense Bone JDIcon Plus
JDDICS5	Short Drill Ø 5mm L 6 JDIcon Plus





## Implant and Prosthetic Drivers:





EVID:	Implant Driver JDEvolution Plus	
EVIDL:	Implant Driver Long JDEvolution Plus	
JDID127	Implant Depth Aligner JDEvolution Plus	
EVSDPF15:	Prosthetic Driver for JDTorque L 15 JDEvolution Plus	
EVSDPF20:	Prosthetic Driver for JDTorque L 20 JDEvolution Plus	
EVSDPF25:	Prosthetic Driver for JDTorque L 25 JDEvolution Plus	
EVSDPF35:	Prosthetic Driver for JDTorque L 35 JDEvolution Plus	
EVSDPF60:	Prosthetic Driver for JDTorque L 60 JDEvolution Plus	
EVSDCAF	Conical Abutment Driver for JDTorque	
EVSDP20:	Prosthetic Driver L 20 JDEvolution Plus	
EVSDP25:	Prosthetic Driver L 25 JDEvolution Plus	
EVSDP30:	Prosthetic Driver L 30 JDEvolution Plus	
JDPD105	Prosthetic Driver JDEvolution Plus for Surgical Driver	
EVSDCA	Conical Abutment Drive	
EVSDPF25A	Angulated Screw Driver for JDTorque L 25	
EVSDPF30A	Angulated Screw Driver for JDTorque L 30	
EVSDPF25AV	Angulated Screw Driver for Conical Abutment Direct JDTorque L 25	
EVSDPF30AV	Angulated Screw Driver for Conical Abutment Direct JDTorque L 30	
EVSUD	Surgical Driver JDEvolution	
JDG	JDGuide	
EVGMC	Implant Mounter for JDEvolution	
EVGMLC	Implant Mounter Long JDEvolution	
JDID102	ZAPA Tool	

## Direction indicators:

JDDI	Direction Indicator	
JDDIS	Direction Indicator Short	
JDDI17	Direction Indicator 17°	
JDDI30	Direction Indicator 30°	
JDDI45	Direction Indicator 45°	

# DRILLING PROTOCOLS

It is recommended to adhere to the indications of the following drilling sequence to ensure optimal primary stability of the implants

IMPLANT DIAMETER	HEALED BONE		POST EXTRACTIVE BONE		
	SOFT BONE	MEDIUM-DENSE BONE	SOFT BONE	MEDIUM-DENSE BONE	
<b>site preparation in maxilla</b>					
Ø 3,7	2,0 2,4 2,8 up to the 1 <sup>st</sup> laser mark L6mm	2,0 2,4 2,8 3,2 up to the 1 <sup>st</sup> laser mark L6mm	2,0 2,4 2,8 at the entrance	2,0 2,4 2,8 at the entrance	  <p>Short Implant L 6mm JDEvolution Plus insertion in maxilla</p>
Ø 4,3	2,0 2,4 2,8 3,2 at the entrance	2,0 2,4 2,8 3,2 up to the 1 <sup>st</sup> laser mark L6-8mm 3,6 at the entrance	2,0 2,4 2,8 3,2 at the entrance	2,0 2,4 2,8 3,2 at the entrance	
Ø 5,0	2,0 2,4 2,8 3,2 3,6 up to the 1 <sup>st</sup> laser mark L 6mm	2,0 2,4 2,8 3,2 3,6 up to the 1 <sup>st</sup> laser mark L 6mm 4,0 at the entrance	2,0 2,4 2,8 3,2 3,6 at the entrance up to the 1 <sup>st</sup> laser mark L 6mm	2,0 2,4 2,8 3,2 3,6 at the entrance up to the 1 <sup>st</sup> laser mark L 6mm	
Ø 6,0	2,0 2,4 2,8 3,2 3,6	2,0 2,4 2,8 3,2 3,6 4,0 4,4 up to the 1 <sup>st</sup> laser mark L 6mm	2,0 2,4 2,8 3,2 3,6 4,0	2,0 2,4 2,8 3,2 3,6 4,0	
<b>site preparation in mandible</b>					
Ø 3,7	2,0 2,4 2,8 3,2 up to the 2 <sup>nd</sup> laser mark L 8mm 3,6 up to the 1 <sup>st</sup> laser mark L 6mm	2,0 2,4 2,8 3,2 3,6 up to the 1 <sup>st</sup> laser mark L 6mm	2,0 2,4 2,8 3,2 at the entrance	2,0 2,4 2,8 3,2 at the entrance	  <p>Short Implant L 6mm JDEvolution Plus insertion in mandible</p>
Ø 4,3	2,0 2,4 2,8 3,2 3,6 up to the 2 <sup>nd</sup> laser mark L 8mm 4,0 up to the 2 <sup>nd</sup> laser mark L 8mm	2,0 2,4 2,8 3,2 3,6 4,0 up to the 2 <sup>nd</sup> laser mark L8mm 4,4 up to the 1 <sup>st</sup> laser mark L 6mm	2,0 2,4 2,8 3,2 3,6 at the entrance	2,0 2,4 2,8 3,2 3,6 at the entrance	
Ø 5,0	2,0 2,4 2,8 3,2 3,6 4,0 4,4 up to the 2 <sup>nd</sup> laser mark L 8mm 4,8 at the entrance	2,0 2,4 2,8 3,2 3,6 4,0 4,4 4,8 at the entrance	2,0 2,4 2,8 3,2 3,6 4,0 at the entrance	2,0 2,4 2,8 3,2 3,6 4,0 at the entrance	
Ø 6,0	2,0 2,4 2,8 3,2 3,6 4,0 4,4 up to the 2 <sup>nd</sup> laser mark L 8mm 4,8 up to the 2 <sup>nd</sup> laser mark L 8mm	2,0 2,4 2,8 3,2 3,6 4,0 4,4 4,8 up to the 2 <sup>nd</sup> laser mark L 8mm	2,0 2,4 2,8 3,2 3,6 4,0 4,4	2,0 2,4 2,8 3,2 3,6 4,0 4,4	

Note: All measurements in mm

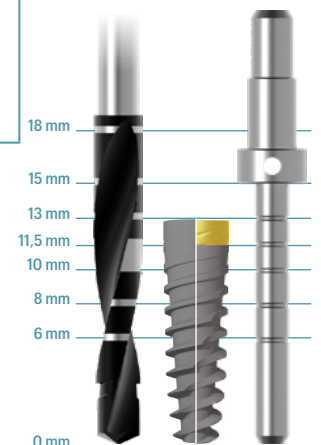

# DRILLING PROTOCOLS - Ø 4,0 IMPLANTS

It is recommended to adhere to the indications of the following drilling sequence to ensure optimal primary stability of the implants.

		HEALED BONE		POST EXTRACTIVE BONE			
IMPLANT DIAMETER		SOFT BONE	MEDIUM-DENSE BONE	SOFT BONE	MEDIUM-DENSE BONE		
<b>site preparation in maxilla</b>						Short Implant L 6mm JDEvolution Plus insertion in maxilla	
Ø 4,0	2.0	2.0	2.0	2.0	2.0	short Ø 4,0 L 6	Start the osteotomy with standard twist drill Ø 2.0mm and Ø 2.4mm Complete with the Ø 4mm L 6mm drill code JDDICS4
	2.4	2.4	2.4	2.4	2.4		
	2.8	2.8	2.8	2.8 up to the 2 <sup>nd</sup> laser mark L 8mm	2.8		
		3.2 up to the 2 <sup>nd</sup> laser mark L 8mm	3.2 up to the 2 <sup>nd</sup> laser mark L 8mm				
		3.6 up to the 2 <sup>nd</sup> laser mark L 8mm	3.6 up to the 2 <sup>nd</sup> laser mark L 8mm				
<b>site preparation in mandible</b>						Short Implant L 6mm JDEvolution Plus insertion in mandible	
Ø 4,0	2.0	2.0	2.0	2.0	2.0	short Ø 4,0 L 6	Start the osteotomy with standard twist drill Ø 2.0mm, Ø 2.4mm and Ø 2.8mm Complete with the Ø 4mm L 6mm drill code JDDICS4D
	2.4	2.4	2.4	2.4	2.4		
	2.8	2.8	2.8	2.8	2.8		
	3.2 up to the 2 <sup>nd</sup> laser mark L 8mm	3.2	3.2 up to the 2 <sup>nd</sup> laser mark L 8mm	3.2 up to the 2 <sup>nd</sup> laser mark L 8mm	3.2		
	3.6 up to the 2 <sup>nd</sup> laser mark L 8mm	3.6	3.6 up to the 2 <sup>nd</sup> laser mark L 8mm	3.6 up to the 2 <sup>nd</sup> laser mark L 8mm	3.6 up to the 2 <sup>nd</sup> laser mark L 8mm		
		4.0 up to the 1 <sup>st</sup> laser mark L 6mm					

Note: all measurements in mm



**JDENTALCARE**

[www.jdentalcare.com](http://www.jdentalcare.com)

JDentalCare, the JDentalCare logo and other trademarks mentioned in this document are, excluding specifically mentioned exceptions, trademarks property of JDentalCare.  
The images of the products represented in this brochure are not necessarily to scale.

Note: Not all products manufactured by JDentalCare and represented in this brochure have been regulatory cleared/released for sale in all countries and/or have been licensed in accordance with FDA Rules and Regulations.  
For more information about current product assortment and availability, please contact your local JDentalCare distributor. For prescription only.

Caution: Federal (US) law restricts this device to sale by or on the other for a licensed dentist. See instructions for use for more information such as indications, warnings, precaution and contraindications.

REV.57 of 2024-09-10